



MOVING
FORWARD ▶

2014 ANNUAL REVIEW

The mission of **ABS** is to serve the public interest as well as the needs of our members and clients by promoting the security of life and property and preserving the natural environment.

TABLE OF CONTENTS

- 1** Overview
- 2** Chairman's Message
- 8** Spirit of ABS
- 12** ABS COO Message
- 14** Class Activity
- 20** Marine Activity
- 32** Offshore Activity
- 40** Government Activity
- 42** Innovation & Research
- 50** ABS Group CEO Message
- 52** ABS Group Overview
- 60** Endowing the Future
- 63** Corporate Governance
- 66** ABS Group Governance



LEVERAGING INNOVATION TO LEAD ▶

The strong efforts of our worldwide staff in 2014 brought ABS another year of solid growth highlighted by innovation and milestone technical achievements.

These milestones include classification of the world's first compressed natural gas carrier, landmark studies on liquefied natural gas bunkering and of Approvals In Principle for innovative offshore exploration and production technologies. There was also groundbreaking research into vessel-ice collision that led to development of a revolutionary new 'design by simulation' technology for steel structures destined for harsh-environment and Arctic service.

The focus of ABS is to provide classification services to promote the common safety, environmental and regulatory interests of its members and clients, including builders, owners and operators of ships and marine-related facilities. This core classification activity grew substantially in 2014, bringing the worldwide ABS-classed fleet to a new record level.

ABS Group of Companies, Inc., a wholly-owned subsidiary of ABS and its subsidiaries (ABS Group), provides technical solutions to support safe, reliable and high-performance operations for assets and operations and offers a portfolio of comprehensive products and services to enhance life cycle management. ABS Group continued to grow in 2014, despite tough economic times for many of the sectors in which it operates.

Together, ABS and ABS Group continued to set standards and develop technologies to help the maritime and offshore energy industries meet their future challenges safely, efficiently and responsibly. ▶



BRAVING NEW FRONTIERS ▶

2014 was a banner year for ABS. Our success was driven by the passion, commitment and dedication of our people. We continued to look outward and forward – extending the horizons, taking on industry challenges, investing in research and development and laying the groundwork for defining the future of Class.

ABS maintained its position in the top tier of the marine industry, surpassing the 220 million gross tons mark, the result of a record net gain of tonnage from a combination of a high level of newbuild deliveries and achieving the best net transfer of class activity in two decades. In 2014, we once again finished the year with the number one orderbook share in gross tons, despite intense competition and the merger of some of our prime competitors.

In the offshore sector, where ABS has been identified with every barrier breaking technology, we continued to set the pace, classing a record number of high-specification offshore support vessels and being selected to class the first floating liquefied natural gas unit.

The acknowledged frontrunner in the gas sector, ABS closed out 2014 with a larger percentage of the liquefied petroleum gas, very large gas carrier, and liquefied natural gas-fueled vessel segments and classed both the world's first contracted series of very large ethane carriers and the world's first compressed natural gas carrier.

When clients needed fleet performance support, ABS made the Asset Performance Management group available as a resource. Last year, in addition to assisting clients with evaluating which ballast water management systems have the capabilities to meet their regulatory needs, the Asset Performance Management group also applied specialized knowledge of computational fluid dynamics to practically assess the challenges to improving efficiency in vessel performance. Our work centered on bulbous bow retrofits, hull form performance and impacts of energy-saving devices that will ultimately have a positive impact on the environment.



In 2014, ABS continued to invest in the Nautical Systems Fleet Management software suite and released the new Hull Manager 3D module. This new interactive tool facilitates vessel condition tracking and structural assessment to support asset life extension. ABS continues to set the bar for performance, making history time and again with achievements that put our organization head and shoulders above the competition. Every member of the ABS team should be proud of the continued recognition in the marketplace of our Class-centric strategy and exemplary Class services.

THE BACKBONE OF ABS

People continue to be the driving force at ABS. Our employees are passionate about what they do and are keenly aware of how their work impacts our clients. For our employees, the ABS mission is the “True North” that guides their actions every day.



ABS employees understand that safety is a responsibility, not a business. They have embraced the ABS *Always Be Safe* initiative and have woven it into the fabric of their work. This is the hallmark of a high-performing organization, and it is their commitment to safety and dedication to a job well done that earns the trust of the industries we serve.

ABS ended 2014 with two lost time incidents. While this is indicative of an ever improving safety record, we are convinced that zero lost time incidents is achievable, and we continue to work toward that goal. One way we are doing so is through an increased focus on driving safety, an initiative that was rolled out in 2014. Our employees already are on board with our new requirements and are adjusting their behavior to comply with the new expectations.

ABS employees understand that we trade on our integrity every day, and we are committed to maintaining the highest level of ethical conduct in all of our actions. In keeping with our continued commitment to compliance and ensuring that employees are equipped to make the right choices in difficult situations, we began a phased rollout of online and classroom ethics and compliance training across the global organization last year.

When clients engage ABS they do so, in large part, because they value our unparalleled focus on safety and integrity in conducting business coupled with an investment in technological development. ABS is a technology-driven organization. The core engineering and technology competence of our people and the wealth of experience they bring to problem-solving continues to be a key differentiator for us.

We are recruiting new graduates and hiring them into the Aspire Program, providing them with a structured rotation through different departments within the company to expose them to the varied roles that are critical to a high-performance organization. Moreover, we are increasing our investment in training and career development by focusing on our people in an effort to identify potential, build leadership skills, and provide growth opportunities for every ABS employee.

People are our most valuable asset. By investing in people, ABS is investing in the future.

FUTURE OF CLASS

Vision and foresight are vital to our continued success. We recognize that Class services cannot stagnate and that the future of classification goes beyond traditional safety certification.

ABS is refining and shaping Class through a proactive approach to resolving challenges, finding pragmatic approaches to create safety guidelines for challenging new environments, advancing innovative solutions for safe and efficient operations, and fearlessly tackling new technologies that will change the definition of Class.

This is essential to maintaining the confidence of industry and to ensuring that the role of Class remains in touch with rapidly changing industry needs. As the marine and oil and gas industries evolve, so do the expectations for Class services. Customers want effective and efficient service delivery and nonintrusive surveys. We know these challenges well, and we are exploring ways to meet them.

FutureClass will be characterized as condition-based, continuous and risk-driven. This next step forward focuses on the importance of data-driven and predictive analytics. Big Data will be the catalyst that ties together regulations of the future with technological advancements and Class of the Future. Big Data will help the industry shape the risk protection frontier.

Data-driven classification is recognizing and understanding the relationships among and between structured and unstructured data that will provide useful insight into scalability, trending and forecasting. Harnessing Big Data through intelligent system monitoring that allows real-time information to be used to improve performance will undoubtedly deliver huge returns.

These changes will be revolutionary, introducing new ways of approaching our work, and in the end, redefining Class without redefining the safety mission that is at its core.

The steps we take in the next few years will be guided by our unwavering commitment to our mission to promote the security of life and property and preserve the natural environment. The path we are forging is one that will



carry us further down the road toward peak performance by applying unique optimized techniques that will continue to place ABS in a class by itself.

At ABS, we are not waiting for others to break new ground. We are leading the way.

ABS GROUP

As the preferred strategic partner for ABS, ABS Group leverages synergies between the two organizations to expand the scope of services offered to meet a broad range of client needs. In 2014, ABS Group continued to prove itself a leader in technical services that enabled clients to improve operational safety, reliability and efficiency.

The emphasis last year on delivering exceptional offerings led an expanded network of clients across key markets, including technical inspection; safety, risk, and compliance; asset performance optimization; and advanced engineering.

ABS Group has refined its focus on reliability and maintenance services, particularly for the global offshore oil and gas industry and North American power and energy sector. Going forward, the company will continue to raise its profile in these two markets by providing innovative and practical technical solutions that maximize business performance. With these changes, ABS Group is positioning itself for continued growth and success in 2015 and beyond.

In the same spirit as ABS, safety and integrity underlie all that ABS Group does. After several years of stellar performance on the safety front, ABS Group sadly lost a colleague in a driving accident this past year. This unfortunate incident along with some other safety-related driving incidents in ABS prompted an evaluation of our driving policy and caused us to further increase our safety initiatives across both companies. Likewise, the employees of ABS Group have embraced the strong Ethics & Compliance program that has been developed and implemented over the last couple of years.

LOOKING AHEAD

As we move forward into 2015, I want to thank our members and clients for their support and trust, and I also want to thank the employees for their continued loyalty and enthusiasm as they carry out critical functions for the company. It is what makes ABS and its affiliated companies unique.

While market conditions at the conclusion of 2014 posed serious challenges for the year ahead, we are prepared to meet those challenges head on.

Our vision is to build on our strengths through investment in people, technology and tools to ensure that we have the proper resources and competencies in place to retain our competitive edge and to move toward defining and providing the next generation of Class and Class-related services.

ABS and ABS Group are organizations on the move. With a strong long-term business strategy that leverages our strengths in service delivery and client engagement, we are well placed to navigate the choppy waters that lie ahead.

We have built a strong foundation for the continued success of ABS and ABS Group. By working conscientiously every day to respond to the needs of our clients, we will remain at the forefront of the industries we serve – ABS a global leader in classification and risk management and ABS Group a global leader in technical consulting services and a strategic partner for ABS.

While the future is uncertain, one thing will not change, and that is our commitment to safety and integrity in the industries that we serve, a responsibility and a commitment that is non-negotiable.



Christopher J. Wiernicki
Chairman, President & CEO of ABS
Chairman, ABS Group of Companies, Inc.

THE SPIRIT OF ABS IN ACTION ▶

The *Spirit of ABS* is rooted in timeless elements that are as important today as when the company was founded over 150 years ago. These elements provide the guiding principles behind the road map for ABS and ABS Group, as they pursue their respective missions.

The *Spirit of ABS* – which is about people working as a team to reliably deliver innovation and quality with integrity – comprises the principles that bond ABS and its affiliated companies together globally and make it unique. It is the framework for the way ABS conducts business in service of the public, industries and clients.

SUPPORTING OUR PEOPLE

People make the difference for ABS and ABS Group. Every day, the more than 5,000 global team members of ABS and ABS Group partner with clients to deliver safety and environmental solutions. People were the focus of 2014's FusionHR initiative, which provides improved ways of documenting development goals and managing performance, while also effectively matching people with assignments in ways that benefit the individuals and the organizations.





The Aspire rotational training program expanded, offering nearly 40 recent engineering graduates exposure to a range of career paths during their first 14 months of employment.

This focus on career development will help prepare employees to address client and industry challenges in the next decade and beyond.

DRIVING INDUSTRY INNOVATION

People drive technological innovations, and ABS and ABS Group delivered many new offerings in 2014. Innovations by ABS provided real, quantifiable results for clients in areas as diverse as helping make assets and structures safer in harsh Arctic conditions, developing software system enhancements and improving propulsion efficiency through computational fluid dynamics.

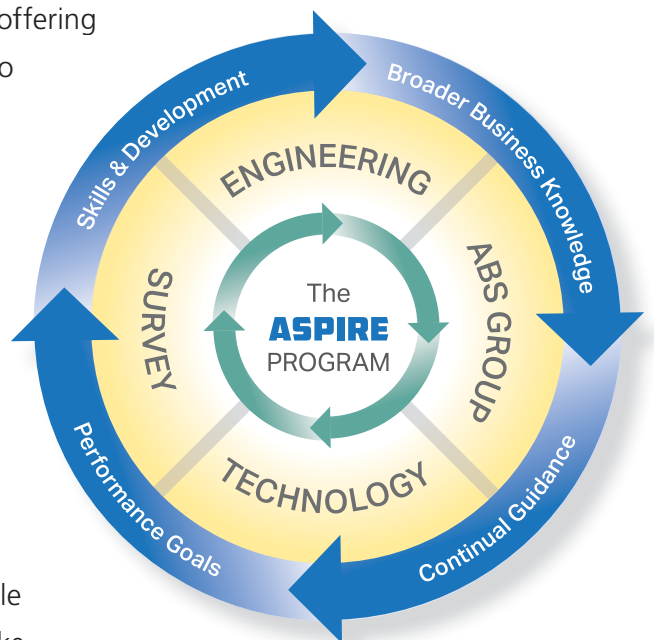



For ABS Group, several successes were driven by innovation in areas such as wind energy generation.

Innovation wasn't limited to products and services. For example, a state-of-the-art ABS website launched in October to more effectively engage members, clients and industry stakeholders.

DELIVERING QUALITY IN A RELIABLE MANNER

When industries need standards for safety and environmental compliance, ABS and ABS Group deliver in a consistent manner. The quality management systems for ABS and ABS Group drive continual improvement in operations for these organizations, laying the groundwork for their ISO 9001, ISO 14001 and OHSAS 18001 certifications and – in the case of ABS – certification to the IACS statement of compliance.

STRENGTHENING SAFETY CULTURE

A key component of the *Spirit of ABS* is safety. Globally, ABS and ABS Group employees maintained a strong safety performance in 2014, and their engagement increased for such leading safety behaviors as documenting near misses and the timely reporting of potential incidents or risks. The *Take 5* safety campaign expanded to include “at work and at home” aspects, noting that safety is important not only on the job, but also in everyday life.

WORKING WITH INTEGRITY

ABS and ABS Group clients depend on and expect a continued commitment to honesty, ethics and trustworthiness, qualities both companies strengthen through education. The annual Compliance Day event, for example, highlighted ways in which ABS makes the right compliance-related decisions. It is part of an ongoing education initiative that, in 2014, included a phased rollout of online and classroom ethics and compliance training programs. ▶

Driving Improvement In Safety

Employees of ABS and ABS Group annually drive tens of thousands of miles on business, and the organizations recognize time on the road as an ongoing source of risk.

That’s why the organizations initiated conversations with global team members at Global Health and Safety Day events during September. The discussions covered ways of strengthening ABS and ABS Group training, policies and, ultimately, driving safety performance. This focus on driving safety was evident in a campaign about safe driving habits and in the development of a strengthened policy and training program.

ABS and ABS Group each built upon their overall safety performance in 2014, as the organizations continued their process of improvement towards the goal of zero accidents and incidents globally.





GLOBAL OPERATIONAL EXCELLENCE ▶

ABS delivered a strong year in 2014 by focusing on quality, operational excellence in service delivery, and targeted investment.

WORLD CLASS SERVICE DELIVERY EMPOWERS GROWTH

ABS' class-centric focus resonated with the marine and offshore industries in 2014. The ABS-classed fleet expanded to the highest level in company history, and the organization added significantly to its orderbook.

From the beginning, ABS has focused on exceptional service and client support, and those efforts paid off in the Marine sector once again, positioning ABS as the go-to Class society in major shipbuilding and shipowning countries around the globe. This focus also led to the continued strong track record in Port State Control performance for the ABS-classed fleet and allowed ABS to achieve another historic milestone as it became the first foreign classification society to serve as a recognized organization on a Japanese-flagged vessel.

Our organization saw similar, positive milestones in the Offshore sector. Last year, we realigned and augmented our Offshore Leadership team to provide even better resources for asset owners that want to find ways to advance safely into operational frontiers, increase uptime, improve productivity, and extend the life of offshore assets. In a move to be more accessible to our clients in Houston, we opened a new office in the Energy Corridor, which today houses approximately 90 Offshore team members.

Recognizing several years ago that gas was entering a "Golden Age" and that this would become a rapidly expanding market segment, ABS geared up to lead the charge in providing global gas solutions, a move that has led to an increased number of large vessels classed to ABS and doubling of our orderbook and market share of very large liquefied petroleum gas carriers over the course of the year. The gas team began working with designers, granting Approval In Principle for novel floating liquefied natural gas concepts and has led the movement in the US to use liquefied natural gas to fuel vessels. In yet another industry first, ABS had the honor of being selected to collaborate on what is expected to be the first liquefied natural gas-fueled drillship, an innovation that will promote energy efficiency and environmental sustainability in offshore exploration.

ABS also invested last year in training. Through our global academies in Singapore, Shanghai, Athens, Busan and Houston, we delivered nearly 300 specialized training classes to Marine and Offshore clients. Courses ranged from understanding and meeting new regulatory challenges, to analyzing shipboard risks, to instruction on emerging industry topics, including liquefied natural gas-fueled vessels, floating liquefied natural gas, inspection and maintenance for mobile offshore drilling units, and floating production storage and offloading class requirements.

The broad range of our successes demonstrates our high-quality service and our leadership in addressing the technical challenges of the industries we serve. Our ability to apply core engineering and technical knowledge along with extensive experience will continue to be a key differentiator in developing practical, innovative solutions that help the industries we serve.



TARGETED INVESTMENTS

In 2014, our research program included more than 200 technical projects. Programs focused on harsh environment operations, human factors engineering, subsea operations, asset performance, environmental sustainability, and the use of future fuels. In each case, our technology investments target ways to drive continuous improvements in safety.

Our investment in the future is not confined to research. ABS continues to make major contributions to maritime academies and engineering universities, endowing chairs in naval architecture and marine engineering and partnering with the academic community to support curriculum modernization.

At the heart and soul of ABS is the desire to invest in tools to support people and processes, deliver world-class service, and pioneer the evolution of class. Our continued goal is to work with industry to support safety in marine and offshore operations.

A handwritten signature in black ink, appearing to read 'Tony Nassif'. The signature is stylized and fluid.

Tony Nassif
Executive Vice President & COO, ABS



CONTINUED RECORD OF GROWTH ▶

In 2014, strengthened global economics and the push for more technically sophisticated assets across both the marine and offshore industries, led to further strengthening of the global shipbuilding market. Within this dynamic, the ABS-classed fleet saw another year of growth and continued strengthening of the orderbook.

CONTINUED RECORD OF GROWTH

At the end of the year the ABS-classed fleet had expanded by more than 15m gt from 2013. This was driven by a combination of new vessels delivered while at the same time Transfer of Class Agreements brought in a net total of 5m gt to the ABS-classed fleet. In total the ABS fleet grew by more than 7 percent year-on-year.

The strength of ABS' performance in 2014 was not just found in existing vessels, but also in new orders. ABS closed the year with nearly 50m gt on order at shipyards around the world. This represented a nearly 20 percent increase in orderbook year-on-year, and the second straight year of growth since the most recent global downturn. ABS is firmly positioned as the classification society with the largest orderbook in the world.



© Almirante Shipping S.A.

A GLOBAL FOOTPRINT FOR THE FUTURE

The near term success of the ABS-classed fleet looks to continue well into the future, as ABS leverages its global service network to assist builders and operators around the world. At the end of 2014, ABS was the leading classification society for vessels under construction in China, Brazil, the United States, Singapore, India and the United Arab Emirates.

ABS was also the preferred non-national classification society in Japan, where its total share of the orderbook increased by 50 percent, building upon its recent selection as a Recognized Organization of the government. ABS also continued to build upon its strong presence in South Korea, with nearly one-quarter of all assets under construction in the country being built to ABS class.



VESSELS ON ORDER 2014

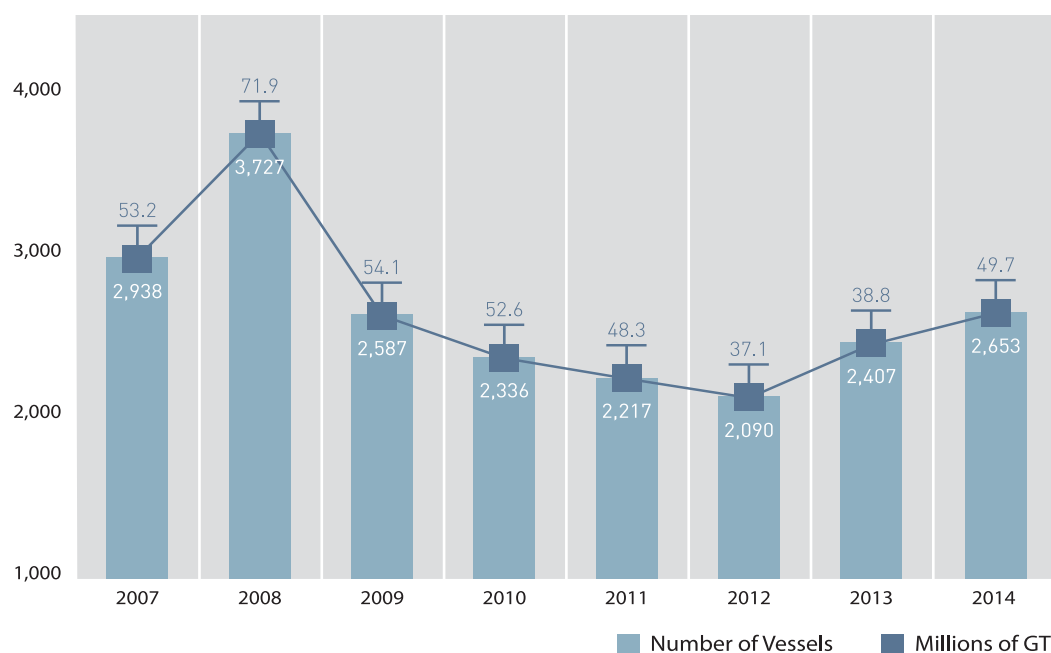



MARINE ACTIVITY

The global marketplace saw an increased focus on gas and its wide-ranging potential. The society added 26 new gas carriers to the orderbook, capturing more than 31 percent of the liquefied natural gas carrier orderbook while also adding several innovative projects related to compressed natural gas and ethane. ABS also saw continued success in the liquefied petroleum gas carrier market, where it currently holds 23 percent of the very large vessels on order.



© Psara Shipping Corporation

The oil tanker sector continues to comprise the largest amount of tonnage within the ABS-classed fleet. Over the course of the year ABS-classed tankers grew from 73.8m gt to 77.4m gt for a total of 1,337 vessels. 192 additional tankers representing 10.6m gt are on order to ABS class. This success continued across all segments of the tanker market, with particular strength in the medium-range tankers where ABS captured 65 percent of the current orderbook. There was also significant success in the very large crude carrier market where ABS recaptured the leading orderbook share at 34 percent.

EXISTING FLEET 2014

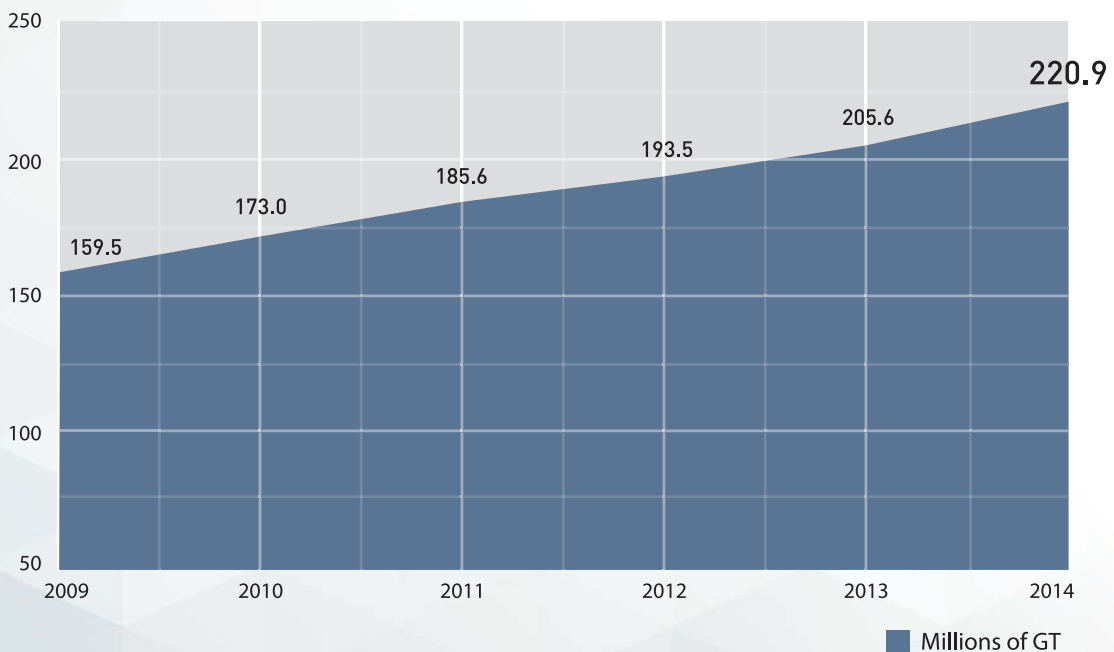

ORDERBOOK SHARE 2014

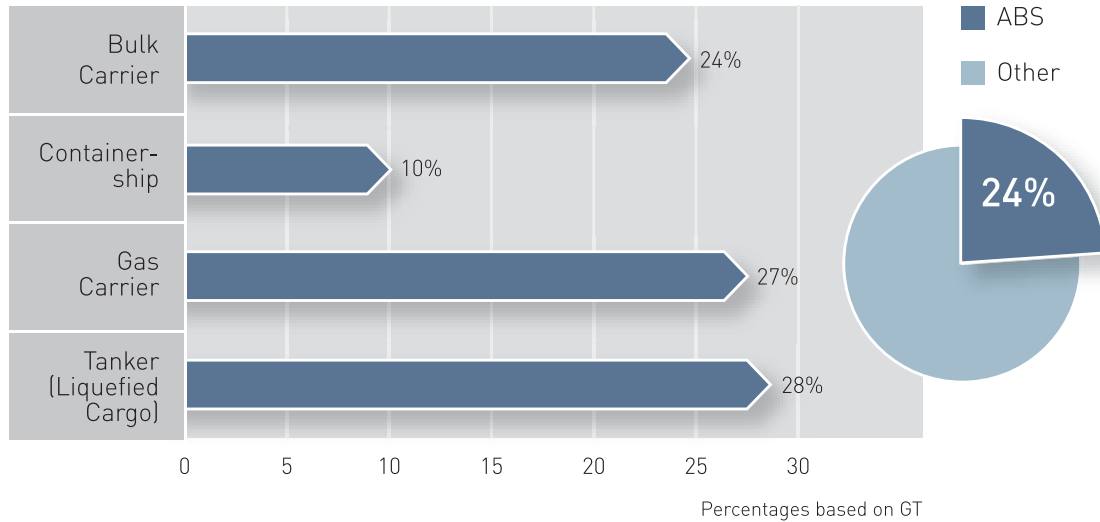

In the bulk carrier market ABS had a net increase of more than 30 new vessels to its fleet, bringing the total tonnage for the sector to 45.9m gt. An additional 351 bulk carriers representing 20.1m gt are on order to ABS class.

Overall the ABS-classed fleet age profile provides a solid foundation for the long term success of the society. More than two-thirds of all vessels under ABS class are 10 years or younger, with nearly half of the fleet in operation for less than five years.

OFFSHORE ACTIVITY

ABS began 2014 with a strong position in the offshore market, maintaining its leading class share for mobile offshore drilling units and floating production installations. ABS continues to have the lion's share of the jackup market, ending the year with an 84 percent share. In both the drillship and semisubmersible sectors, ABS held a 56 percent share at the year's end.





The market share for production units also was impressive, with year-end standings showing ABS in the lead, classing 75 percent of the tension leg platforms and 90 percent of the spars in operation. Although the percentages for production semisubmersibles, and floating production, storage and offloading units were lower, ABS closed out the year with a 45 percent share of offshore production units in operation.

And in the offshore support vessel sector, where ABS has led from the beginning, the organization added to the number of high-specification multipurpose units under ABS class.

OFFSHORE EXPLORATION UNITS 2014

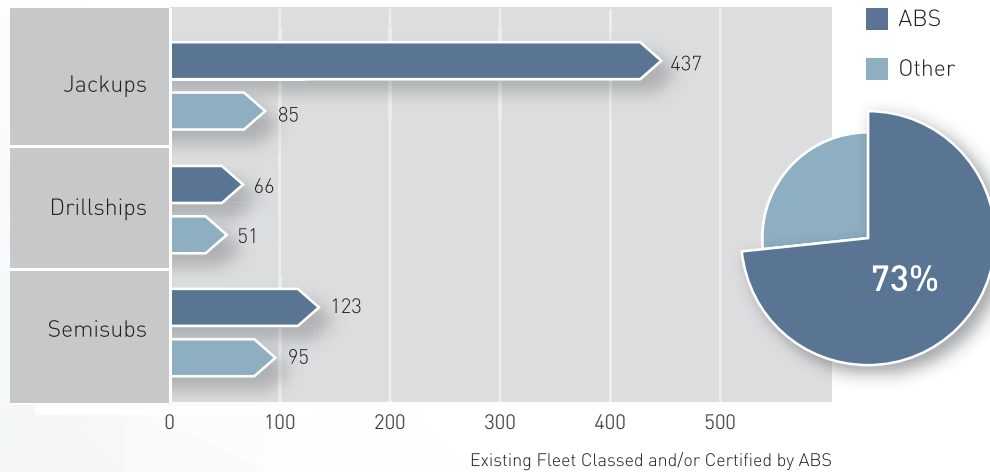

OFFSHORE PRODUCTION UNITS 2014

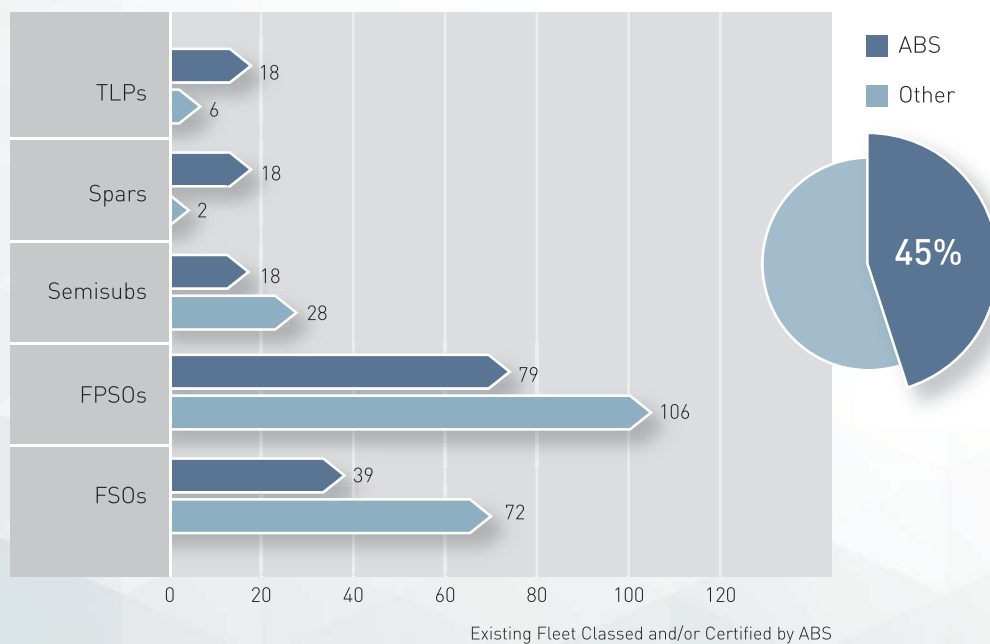

CLASS PERFORMANCE

A key element driving the continued expansion of the ABS-classed fleet and client base is the ability to deliver high quality service consistently throughout the world. 2014 was no exception as independent bodies around the world continued to highlight the strong safety performance of the ABS-classed fleet. The year also closed with the ABS-classed fleet once again performing better than industry averages as it related to both overall serious casualties and serious hull and machinery casualties. ▶



SERIOUS CASUALTIES PER 1,000 VESSELS

Three-year rolling average
Seagoing vessels > 500 gt

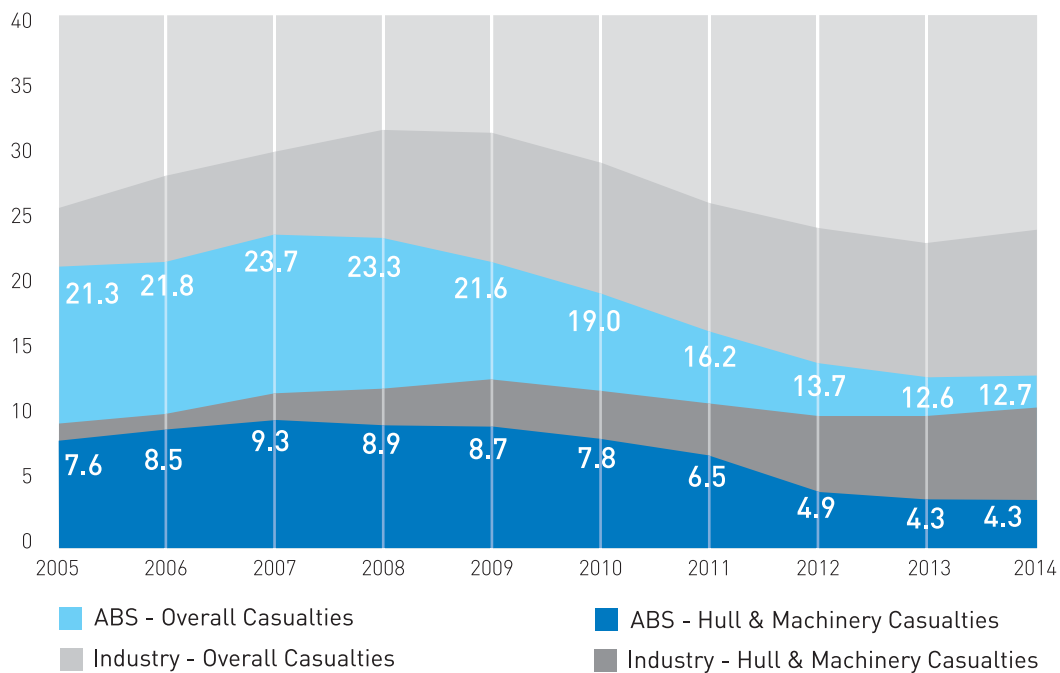



MAINTAINING A HERITAGE OF TECHNOLOGY LEADERSHIP ▶

In a challenging year that fully demonstrated the unpredictability of global shipping markets, ABS maintained its position as a first-class partner to the international maritime industry.

The need to maintain high-quality operations came against an ongoing backdrop of tightening global and regional environmental regulation, with milestone deadlines at the forefront of owners' minds through the year. During this time, ABS continued to demonstrate its understanding of industry needs and provide the solutions required to meet these challenges. Strong focus in the owner and builder markets, like Greece, Germany and Japan, were instrumental to overall success and market share growth.

One notable example of ABS' continued industry leadership in 2014 was its role in advancing development of liquefied natural gas (LNG) technologies.

Throughout the year, ABS again demonstrated unrivalled technical knowledge and leadership in the maritime transportation of natural gas. In addition to supporting the most innovative gas shipping projects, proven understanding of the practical application of gas as fuel has made ABS the leader in this exciting and still evolving sector.

GAS TRENDS

ABS remains the only classification society to have classed every type of LNG containment technology ever built, and the ABS-classed fleet includes all currently available containment systems. Underscoring this legacy, ABS has approvals ongoing for novel concepts such as the application of new LNG containment system designs and technologies intended to reduce cargo boil-off and enhance safety in day-to-day operations.

One growing gas sector trend is the 'sizing down' of LNG projects to enable them to serve a diverse range of energy demands. For example, future small-scale LNG carriers and floating liquefied natural gas (FLNG) facilities will enable importers to receive gas in smaller quantities and at lower cost than has previously been possible.

The trend towards LNG as fuel is expected to expand, as it is driven primarily by environmental regulations. ABS continues to

Leveraging World Class LNG-As-Fuel Experience

In response to a growing body of environmental regulation, owners and operators around the world are searching for innovative ways to address emission control requirements that do not have a negative impact on operations. Assisted by ABS, a growing number of industry leaders have begun adopting gas fuel as the solution.

In 2014, GNS Shipping/Nordic Hamburg joined those leaders with the design and construction of two ABS-classed 1,400-teu dual-fuel feeder ships for operations in the European Sulfur Emissions Control Area. Under construction at Yangzhou Guoyu Shipbuilding, the vessels feature an innovative design that reduces the impact of LNG bunker tanks on container capacity.





help industry gain experience with LNG as fuel as owners and operators look to expand its applications beyond small vessels and containerships into the broader shipping fleet.

The main engine makers have forged ahead on gas-powered engines and are ready to take the next steps as well. Having already delivered slow-speed, low- and high-pressure gas-powered engines, the manufacturers are also looking at the next stage of this evolution: engines powered by methanol and ethane to support emerging gas trades requiring dedicated tonnage.

MORE MILESTONES IN LNG

ABS invented LNG carrier classification in 1958, when it classed the conversion of a dry cargo vessel into the world's first dedicated LNG carrier. ABS has been a world leader in the field ever since. Some other milestones in LNG carriage include classification of the first purpose-built LNG carrier, the first ice-class LNG carrier and the first large LNG carriers constructed in China.

ABS added to this pedigree in 2014 with the award of a contract for two innovative 'Moss-type' LNG carriers to be built by Hyundai Heavy Industries for Petronas, Malaysia's national oil company. The 150,200-m³ capacity ships will be the largest Moss-type units yet built at HHI's Ulsan yard, and will feature the latest technology to improve energy efficiency and operational reliability.

Today, ABS classes nearly one-quarter of the existing LNG carrier fleet and has the largest orderbook in the sector, with more than 30 percent of all newbuild LNG vessels slated for ABS class. In addition, ABS provided classification for all major containment systems and approval in principle (AIP) for a number of innovative systems and technologies.

The Global Gas Solutions team also provides specification reviews, risk and hazard assessments, bunkering suitability reviews, and project management for new construction and feasibility studies for a wide range of projects. Its industry-leading services help clients satisfy regulatory and statutory requirements and aid development of gas carriers, floating structures and systems, and gas fuel systems and equipment.

Developing LNG Fuel Infrastructure

One fundamental challenge to wide-scale adoption of natural gas as a marine fuel is development of the necessary support infrastructure. Throughout the year, ABS worked alongside industry to help overcome this hurdle.

In 2014 LNG America announced development of a series of first-of-their-kind LNG bunker barges to support North America's growing gas fuel market. Designed, built and maintained to ABS standards, each barge will be a crucial piece in the future gas fuel supply chain.

Alongside this cutting-edge project, ABS released an in-depth study to aid bunkering infrastructure development entitled *Bunkering of Liquefied Natural Gas-Fueled Marine Vessels in North America*.





In addition to industry-leading classification services, the team provides preliminary planning and advice as well as AIP services for next-generation FLNG assets, enabling ABS clients to take new approaches to the worldwide transport of natural gas.

As the maritime industry moves increasingly towards the use of cleaner fuels, ABS has responded with classification services that reflect its heritage and leadership in the use of LNG as fuel.



First-of-its-Kind Ethane Carrier

As the US shale gas boom continued to develop through 2014, many companies found very attractive opportunities to trade ethane on the global market and began searching for innovative transport options to take advantage of this inexpensive and abundant natural gas by-product.

As a result, Reliance, India's largest private-sector enterprise, ordered its first VLECs, which will be built at Samsung Heavy Industries. ABS was chosen as the classification society for this cutting-edge project, adding to its decades-long history of many 'firsts' in the gas industry, dating back to the earliest days of gas transport.

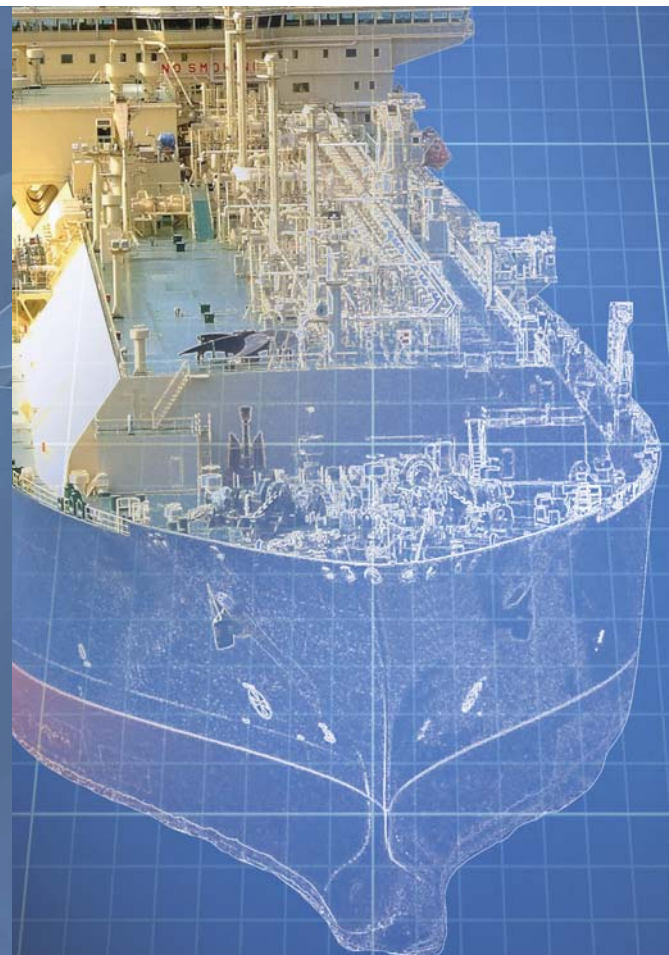

FUELING THE FUTURE

ABS reinforced its leadership in the use of LNG as fuel with the 2014 publication of the updated *Guide for LNG Fuel Ready Vessels*.

ABS has been conducting AIPs for LNG-ready ships for some years. In these cases, the shipowner has defined the level of preparedness to be achieved, but, as each project is different, there has been little consistency between the resulting definitions of 'LNG-ready' and the different degrees of readiness as defined by owners.

To address this gap, the Guide formalizes the process for clients wishing to plan future conversions to LNG fuel by providing a detailed review and approval and an associated class notation.

And while the industry continued the conversation around LNG as fuel, ABS was awarded further classification projects, including two for LNG-fueled containerships to be built in China for German owner GNS Shipping/Nordic Hamburg.

ABS will review the design of the 1,400-teu dual-fuel vessels, survey the construction at Yangzhou Guoyu Shipbuilding Co. Ltd. and class the ships for operation on delivery during 2016 for long-term charter to Containerships Ltd. Oy of Finland.

Taking The Leap Into CNG Transportation

ABS has worked with leading designers and builders for more than a decade in the search for viable options regarding the transportation of CNG. The increasing adoption of gas as a fuel for vessels as well as power plants has finally made CNG carrier development a reality.

In 2014, Pelayaran Bahtera Adhiguna, a subsidiary of Indonesia's state-owned power company PT PLN, ordered the first-ever CNG carrier. Designed to ABS standards by China's CIMC Ocean Engineering Design & Research Institute, the first 2,200 m³ vessel will be built to ABS class at Jiangsu Hantong Ship Heavy Industry.





Meanwhile, increased activity in US shale gas production saw ethane emerge as an exciting new market with great potential, requiring development of new dedicated ship types that will carry exports from the US Gulf through the expanded Panama Canal to buyers in Asia.

FOSTERING INNOVATION

Fostering innovation is a crucial part of the ABS mission. In that spirit, ABS worked with technology developers for many years to help compressed natural gas (CNG) carriers become a reality. In 2014, ABS achieved another breakthrough in the gas sector when it was awarded classification of the world's first CNG carrier, which was ordered by Pelayaran Bahtera Adhiguna of Indonesia and will be built at Qingdao Wuchuan Heavy Industry shipyard in China.



Extending Applications For Gas As Fuel

Using gas as fuel for vessels is one of the ways companies are achieving energy efficiency and environmental sustainability in offshore operations. In a JDP formed between ABS and South Korea's Daewoo Shipbuilding & Marine Engineering (DSME), two recognized global leaders have agreed to apply their combined knowledge and experience to address this issue. The JDP will focus its efforts on challenges associated with safely storing and managing cryogenic LNG, drawing on combining DSME's experience developing and applying LNG technology to floating structures with ABS' extensive involvement in a broad range of gas projects around the world.



The project reflects ABS' longstanding commitment to high-quality service, as well as a market change in which an increasing number of countries are developing their own energy transport chains.

ABS also fosters innovation through participation in joint development projects (JDPs) with industry, one example being the JDP signed last year with South Korea's Daewoo Shipbuilding & Marine Engineering.

Combining DSME's experience in developing and applying LNG technology with ABS' technical standards and long experience with gas-fueled vessels, LNG and regasification unit projects, the JDP will address how to safely store and manage LNG.

Both partners are recognized worldwide as leaders in technology research, shipbuilding, marine engineering and production of commercial vessels and floating equipment. For DSME, ABS' long experience in validating new floating concepts made it a valued partner with which it could collaborate to produce a first-of-its-kind structure employing cutting-edge technologies.

Evolving Floating Gas Production

The global gas landscape is rapidly changing, and that change has led to the emergence of floating, production, storage and offloading vessels designed for LNG (FLNG). ABS has been at the forefront of this evolutionary development, granting AIP for a number of FLNG designs. Sevan Marine ASA's cylindrical FLNG design concept is the latest in the series of designs for which ABS granted AIP. The axio-symmetric hull enables high capacity for LNG storage and large variable deck loads. It is based on the proven circular and geostationary Sevan floating production storage and offloading design already in operation offshore Norway, in the North Sea and offshore Brazil.





ASSET PERFORMANCE

Through its Asset Performance Management group, ABS provided advice and a range of tools to help owners achieve greater operational efficiencies in compliance with environmental and other regulations.

For example, in keeping with its commitment to preserving the natural environment, ABS applied computational fluid dynamic techniques to help shipyards and designers improve the efficiency of newbuildings and existing vessels and used techno-economic modeling to advise clients on the feasibility of new operational measures.

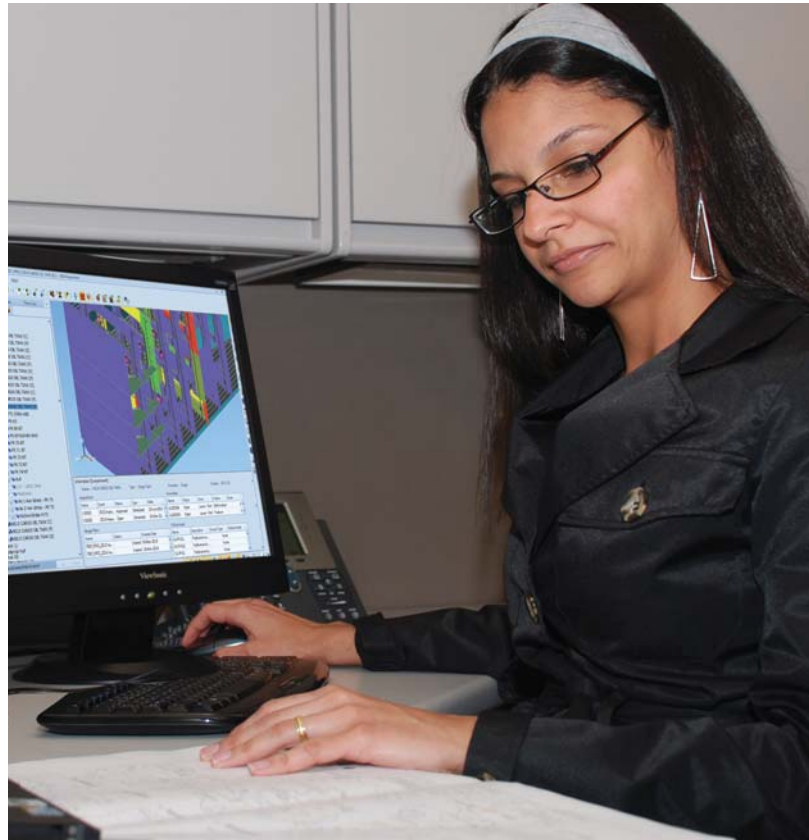

Ballast Water Selection Service

As IMO's Ballast Water Management Convention inches towards entry-into-force and national requirements exert an increasing impact on trade, owners and operators have begun searching for technically sound ballast water management compliance strategies. Their need for help in making informed decisions led ABS to launch its Ballast Water Management System Selection Service.

This service builds on ABS as a leading provider of regulatory compliance assistance. The experienced environmental performance team commands an extensive database of technologies, design capabilities, operational considerations and constraints, coupling this knowledge with a thorough understanding of regulatory requirements to provide a refined solution set that helps owners and operators make informed compliance decisions.

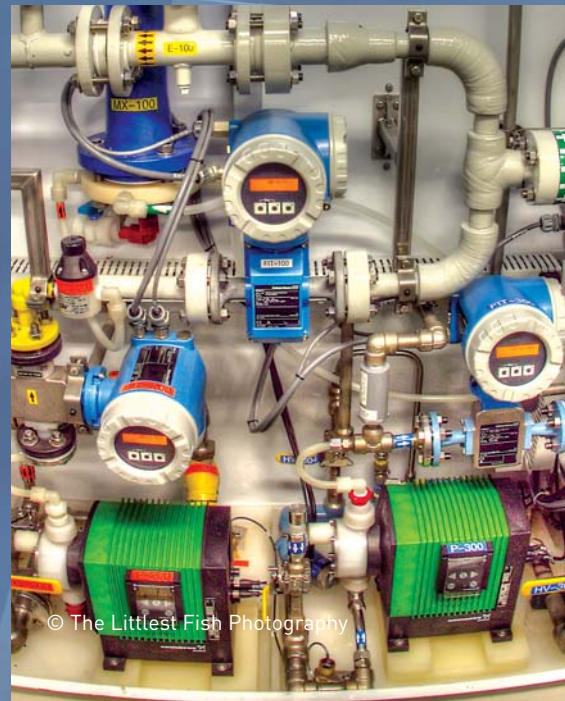

Techno-economic modeling goes beyond technical evaluation of energy-saving measures by providing owners with a fuller understanding of the positive impact of embracing the use of environmental and energy-saving devices. In this way, ABS was able to provide a comprehensive view of the vessel and support client decision-making regarding both energy savings and regulatory compliance.

AIDING IN ENVIRONMENTAL COMPLIANCE

As owners and operators based in and sailing to the US adapted to a low-sulfur fuel environment, ABS provided advice on compliance and best practices while also helping a new generation of vessels become reality. With the deadline for tougher sulfur limits in European waters drawing closer, ABS was selected to class the first LNG-powered ships to sail in the North Sea and Baltic Emission Control Areas.

Although the International Maritime Organization's (IMO) Ballast Water Management Convention remained unratified, ABS continued to be a key information source for owners wanting to understand the US Coast Guard's ballast water management requirements and alternative means of compliance. Through seminars and presentations to flag States and owner groups, ABS conveyed the most up-to-date intelligence and published a specialist Guide to assist in ballast water management system selection.

World Class Service Delivery

Throughout 2014, ABS continued its drive to improve service delivery across the globe. Leveraging its industry-leading presence in more than 70 countries and 200 offices around the world, ABS helped many local and regional members and clients expand their presence globally.

Building on its best-in-class service record, ABS added many new members and clients in 2014. In Germany, for example, ABS expanded its share of the existing fleet by 50 percent and captured 21 percent of the orderbook. One major German shipowner transferred more than 3.2m gt to the ABS-classed fleet. Globally, the ABS-classed fleet grew by nearly 5m gt in existing tonnage through transfer of class.





SHIPPING IN HARSH ENVIRONMENTS

ABS began 2014 with the publication of its *Navigating the Northern Sea Route Advisory*, which aims to support shipowners and operators intending to transit this increasingly attractive commercial shipping route through the Arctic seas.

By year's end, ABS was playing a key role in establishing the standards for polar navigation through its work with the International Association of



Improving Fleet Safety & Performance

TBS Ship Management was an early adopter of Nautical Systems' Safenet software, using it to collect, store and report data for such goals as improving shipboard planned maintenance and monitoring fuel consumption.

Today, TBS utilizes Nautical Systems' Voyage and Energy Manager module to enter data one time for all these needs and more, such as generating the reports needed for Port State Control and environmental impact reporting.

Mindful that the root causes of countless accidents include an officer burdened by paperwork and unable to interrupt a chain of unfortunate events, TBS uses the software to help minimize duplicate reporting, ease onboard administrative burdens, increase efficiency and enhance operational safety.



Classification Societies (IACS). Adoption of the Polar Code by the IMO's Maritime Safety Committee (MSC) will, for the first time, give ship operators in these regions a set of consistent standards on key safety parameters.

The MSC established a correspondence group to advance the development of guidance for assessing operational capabilities and limitations, which is seen as essential to establishing safe and uniformed operational limits in polar shipping.

This group, which includes ABS, was directed by the MSC to consider POLARIS, a standard system for determining operational limitations developed by IACS with the support of administrations including Canada, Russia and Finland. The intent of POLARIS is to provide a consistent, transparent system of guidance for identifying the ice conditions in which a ship can safely operate, depending on its ice class.

Combining leading-edge technology with long experience, ABS once again positioned itself to support innovation in operational efficiencies and the development of safety requirements that are critical to protecting the safety of life, property and the natural environment. ▶

Mitigating Container Loss

In an effort to address concerns about on-deck container losses at sea, ABS launched its container loss mitigation initiative last year, focusing on the non-linear dynamic response of deck container stacks in transit conditions. Using measurements taken during a container loss event, ABS engineers carried out static and dynamic non-linear analyses for a specific vessel, focusing on analyzing the effects of twist lock clearance gaps and multiple nonlinear lashings in conjunction with fully automatic twistlocks. This work lays a firm foundation for providing greater flexibility and functionality in the ABS LASH software and will be critical in the process of revising the relevant ABS *Guide for Container Securing Systems*.





ADVANCING OFFSHORE DEVELOPMENT ▶

Orders for drillships, semisubmersibles, jackups and offshore support vessels (OSVs), while very strong in 2013, fell off somewhat last year. Despite the drop in new construction orders, offshore operations remained solid for the first half of 2014, with production rising over the course of the year in both shallow and deep water.

ABS remained active globally in both market sectors, maintaining strong relationships with shipyards, suppliers, operators and drilling contractors and working closely with industry leaders that are developing innovative solutions to offshore exploration and production challenges.

EXTENDING THE LEAD IN SHALLOW WATER

ABS remains the undisputed frontrunner in jackup classification, ending the year with 25 deliveries around the world and winning 51 awards. The dramatic drop in oil prices in the second half of the year caused the halt or delay of a number of jackup construction projects at year-end, yet ABS remained a committed partner and market leader. Among the ABS-classed units delivered in 2014 was the Seajacks International *Seajacks Hydra*, the fourth self-propelled jackup vessel in the company's expanding fleet.

To help address industry concerns, ABS participated in a focused effort on jackup safety issues last year, convening drilling contractors and other members of the oil and gas industry to discuss today's challenges and tomorrow's

potential solutions. The intelligence gathered during multiple meetings and workshops is being used to enhance the ABS Rules for jackup safety.

HOLDING THE LEAD IN DRILLING & PRODUCTION UNITS

Although ABS maintained its leadership position among classification societies for mobile offshore drilling units, a slowdown in ordering last year meant very few deepwater drilling units added to the orderbooks. On the production side, however, there was considerable activity.

ABS was awarded class and certified verification agent (CVA) work for a number of floating production units across the globe. Projects included a Teekay-chartered floating production storage and offloading (FPSO) vessel for Petrobras' Libra field and a MODEC-chartered FPSO for Petrobras' Tartaruga Verde field. ABS was awarded class on two mobile offshore production units for the Okoro and Okwok fields for Mercator Offshore Nigeria (Pte) Ltd., a floating liquefied natural gas unit *PFLNG2* – which will work on Petronas' Rotan field – and the Hess Stampede tension leg platform for the Gulf of Mexico.

Maintaining Leadership In The Middle East

As a testament to ABS' leading role in the Middle East, Nakilat-Keppel Offshore & Marine (N-KOM) selected ABS to class the LB310S lift boat, the first of its kind to be built in Qatar. The LB310S unit will be constructed as a four-legged liftboat capable of field transit and elevated operations in water depths to 65 m. Built to comply with ABS classification requirements for self-elevating units, it also will carry the DPS-0 notation and will feature lifesaving, fire and gas detection, firefighting, navigation and communication systems installed in compliance with SOLAS, the IMO MODU Code, ABS and flag State requirements.





A contract is in place for class on BP's Mad Dog Phase 2 production semisubmersible along with the award of Structural CVA work for the Shell Appomattox unit, both of which will be installed in the Gulf of Mexico.

SETTING STANDARDS FOR OSVs

Over the past 50 years, offshore E&P has focused largely on shallow water development, but much of the new offshore activity will be in deep water and ultra-deep water, a change in focus that has had significant impact on the OSV sector.



Supporting Offshore Innovation

Addressing the need for a cost-effective and flexible offloading solution in remote regions and harsh environments, Norway-based Remora AS developed the HiLoad technology over a period of 14 years. ABS granted approval in principle (AIP) for the first HiLoad tanker loading and stationkeeping system in 2003 and carried out further assessment to identify the requirements applicable for the HiLoad unit operating in Brazil in 2012. In support of Remora's innovative technology development, ABS granted AIP for the second-generation HiLoad design, which will be able to maneuver vessels larger than suezmax size, such as very large crude carriers with carrying capacity of 320,000 dwt.



OSVs are evolving, becoming increasingly sophisticated and technically advanced, in great part in response to demands from deepwater drilling, production and subsea operations. Today, many OSVs are multipurpose vessels that have capabilities that far exceed those of the fleet only 10 years ago.

ABS also worked closely with Harvey Gulf on its liquefied natural gas-fueled fleet, was selected to class what will be the largest subsea construction vessel in the world, and broke new ground with the classification of dive support OSVs.

When rapid changes in the OSV market left stakeholders with more questions than answers, ABS took on the challenge of educating the industry by hosting multiple seminars around the world to discuss new-generation OSVs and how this extremely dynamic market sector is evolving.

Work that supports Rule development for this sector is ongoing on a broad range of topics, including lifting appliances, harsh environment operations, well intervention and subsea operations, and industrial equipment safety.

Pushing Technology Limits

The offshore industry is advancing at such a swift rate that equipment and systems are being developed in advance of the standards needed to validate them. ABS responded to this rapid advancement by developing and implementing a systematic methodology for qualifying new technology. This innovative process combines a practical “first engineering principles” approach with comprehensive risk assessment and evaluation studies. The new methodology is being employed in the technology qualification of a 20ksi rated well control system and equipment, which is required for the development of a number of recently discovered, deepwater HP/HT fields.





IMPROVING CONSTRUCTION EFFICIENCIES

Recognizing that more automation and an increased use of disparate software was posing hookup, commissioning and software maintenance challenges, ABS began developing its Integrated Software Quality Management (ISQM) program several years ago to address software issues during construction and operation. The process provides a framework for coordinating and controlling the way software development, integration and maintenance are managed throughout the life of an asset.

Rowan Companies, a first mover among drilling contractors in applying this structured software quality management approach, contracted with ABS to employ ISQM in a high-specification drillship newbuild program carried out at Hyundai Heavy Industries in Ulsan, South Korea. Three of the four drillships have been delivered to date, proving the viability of ISQM in a newbuild program and providing experience that can be applied to retrofit programs as well.

PUSHING THE LIMITS OF OPERATING FRONTIERS

Offshore exploration is trending into increasingly deep and more challenging reservoirs, which has increased the overall complexity of well designs and stretched the upper boundaries of equipment performance beyond existing maximum limits.

Drilling high-pressure/high-temperature (HP/HT) wells places new demands on existing equipment, such as subsea blowout preventers (BOPs) and piping and fluid circulating systems. New technology qualification standards for HP/HT discoveries – those rated at more than 15,000 pounds per square inch (psi) and higher than 350°F – must be applied. ABS recognized the need to develop offshore equipment design qualification standards to help designers and manufacturers that are developing and constructing HP/HT subsea BOP stacks and related systems that can be used in 20,000 psi load conditions.

Another technology that is impacting planned offshore drilling operations is managed pressure drilling (MPD). MPD is being used offshore to facilitate drilling previously undrillable wells and to enhance a well's primary well barrier. In addition to defining a technology qualification standards approach for HP/HT drilling, ABS is finalizing requirements that specify certification for MPD systems, including dual-gradient drilling systems and associated subsea components.

Improving Safety Through Software Quality Management

ABS achieved an industry first with the delivery of Rowan Companies' *Rowan Renaissance*, *Rowan Resolute* and *Rowan Reliance* drillships, the first vessels in the world to earn ABS' ISQM notation. This newbuild series, constructed in the Hyundai Heavy Industries yard in Ulsan, South Korea, by the world's largest shipbuilding company, has proven the value of ISQM. No other classification society has classed the drilling equipment and other essential marine equipment with a software notation that addresses software quality during construction, at delivery and beyond. The fourth and final unit is scheduled for delivery in 2015.





ENHANCING SAFETY THROUGH COOPERATIVE INITIATIVES

Safety is far more than a concern or consideration at ABS. It is a core value and the foundation for many initiatives, including last year's decision to form an Offshore Equipment Advisory Committee.

The goals in forming this group are to achieve a refined focus on equipment safety, facilitate information exchange for Rule development and improve the tools industry uses to verify operational safety. Owners and manufacturers will work with ABS to develop new equipment inspection processes that will make certification more efficient while maintaining a strong emphasis on



Extending OSV Capabilities

Changing demands in offshore operations have led to the rapid evolution of OSVs into multipurpose, high-specification units, and ABS is working with designers on the cutting edge. Edison Chouest Offshore and Island Offshore selected ABS to class a next-generation offshore construction vessel with an option for an additional vessel. The ULSTEIN SX165 design vessel is being built at Ulstein Verft in Norway, and is the largest project ever undertaken by this yard. It features a 400-metric-ton crane and three moonpools and can accommodate 200. When completed, it will be the largest subsea construction vessel in the world.



safety. The Offshore Equipment Advisory Committee will give industry experts a forum in which to share experience and knowledge to improve equipment safety.

PARTNERING WITH INDUSTRY

Going forward, the offshore group will strengthen its already robust relationships with industry, convening experts to share their thoughts and experience, and developing and enhancing Rules with the goal of making their application practical and appropriate. This goal is fundamental to ABS' safety mission. The process ABS follows enables and encourages input from industry that allows ABS to produce some of the most comprehensive and thoroughly reviewed Rules and effective classification services in the industry. ▶



Managing Life Cycle Asset Management Through Software

For SBM Offshore, given the long duration of its FPSO lease contracts and operations in corrosive pre-salt fields, it is important to effectively track, analyze and forecast the actual condition of its assets.

Recognizing that lifelong data collection and management are key to maintaining an accurate picture of the health of an offshore asset, SBM Offshore sought a tool that could record overall hull condition, track vessel inspections and create inspection specifications that satisfy classification and their technical standards.

Today, SBM Offshore uses Nautical Systems' Hull Manager software on its worldwide fleet of FPSOs, to help efficiently prepare hull inspection specifications, effectively manage the inspection data and make informed decisions on upgrades to extend the life of their vessels.





SUPPORTING GOVERNMENT FLEETS WORLDWIDE ▶

Government vessel owners and operators faced the same challenges as their commercial counterparts in terms of fiscal constraints and a greater focus on efficiency during 2014, but were also faced with mission changes and new operational demands on their fleets. Continuing its unwavering support of their needs, ABS provided through-life periodic surveys on close to 500 existing vessels, while also broadening and deepening its range of products and services to these clients.

Throughout 2014, ABS made concerted efforts to revise existing long-term agreements and establish new agreements regarding streamlined operational, administrative and fiscal efficiencies for its government stakeholders. ABS supported early start-up needs on key projects such as the US Coast Guard's Offshore Patrol Cutter, the Military Sealift Command's T-AO(X) vessel and the urgent conversion and classification of US Navy vessels that transferred to the Military Sealift Command fleet in order to support the Navy's emerging needs. ABS also conducted condition assessments for 38 auxiliary vessels of the Canadian Royal Navy.

THE FUTURE OF GOVERNMENT VESSELS

Besides working with existing vessels, in 2014 ABS supported 78 new construction projects for various government clients, including Peru, Singapore, India and the United States; 18 of these vessels were delivered during the year. These projects



involved a wide range of vessel types for government agencies, navies, coast guards and others whose missions include safety and security on the high seas, along the coasts and throughout the internal waterways of their nations.

ABS has more than 100 years of experience with government vessels around the world, ranging from large combatants to small patrol craft. This experience is embodied in the *ABS Guide for Building and Classing International Naval Ships*, a new set of Rules published in 2014 that is applicable to naval and government-owned vessels worldwide.

The United States Congress continued to demonstrate the high level of importance that it places on ABS services, expanding ABS' role as a delegated agent of the United States Coast Guard and reaffirming its long-standing role as the official and sole classification society for United States Government-owned vessels. ▶

TAKING THE LEAD IN RESEARCH ▶

Changes in the marine and offshore industries present both challenges and opportunities – the chance to rethink traditional ways of doing things, examine issues from a different perspective, and reimagine solutions. ABS continues to invest in research and development (R&D) to support industry in contending with new technologies, regulations and shifting operating environments.

TACKLING TOUGH PROBLEMS

ABS' Technology program concentrated in 2014 on the most significant maritime and offshore challenges, leveraging program initiatives to support key strategic business development objectives. The program focused on such issues as extreme environments and loads, environmental solutions, asset performance management, energy efficiency, alternative fuels and offshore energy.

ADVANCING IN THE ARCTIC

One of the targets in a broad range of R&D initiatives was the extreme environment of the Arctic, where low temperatures and ice introduce both structural and operational challenges. A number of Arctic research projects are in progress through ABS Technology Centers around the world, including initiatives at the Singapore Innovation and Research Center, where ABS is developing a structural analysis methodology for ice-resistant jackups and assessment of brittle fractures for structural steels in low-temperature applications. The China Offshore Technology Center in Shanghai is applying the Discrete Element Method to investigate ice loads on icebreaking hulls.



And at the Harsh Environment Technology Center in St. John's, Newfoundland, Canada, research includes developing novel technologies to quantitatively assess the effectiveness of physical ice management, which includes performance models of icebreakers in various ice conditions performing different tactical maneuvers. Additionally, ABS is funding a multi-year effort at a major East Coast university on icephobic nanostructured coatings and surfaces, with the aim of developing a performance evaluation standard. At the end of 2014, the program had advanced to the point that equipment was being commissioned for testing.

The Future of Classification

Ships and offshore assets across the globe produce and collect terabytes of data on a daily basis, across a wide range of operational profiles. One key to the future of safety at sea is unlocking these streams of information to drive more-informed decisions.

ABS works closely with industry, governments and other stakeholders in seeking to develop the tools and processes for a sophisticated, data-driven approach to the evaluation and verification of safety standards. This is a multi-year effort whose end goal is development of an efficient, focused, less intrusive classification process that improves safety across the marine and offshore industries by leveraging the latest available data technology.



The offshore support vessel (OSV) sector also is a focus area because it is a rapidly changing segment of the industry, including operations in more exacting operating environments like the Arctic. Recognizing the variety of requirements operators must comply with, ABS has developed a new set of class notations to assist industry in streamlining specifications for harsh environment OSVs.

FOCUSING ON MARINER SAFETY

ABS continues to support the ABS Mariner Personal Safety initiative, a collaborative effort with a university in Texas and more than 30 maritime industry partners. ABS is using this project's worldwide database of maritime injury and near miss reports to identify trends, lessons learned, potential corrective actions, and benchmarking and sharing these with industry. Industry partners have been using project results to help direct safety auditing efforts, focus training and resource allocation through the identification of onboard hazards and to identify potential new hazards related to crew activities.

Improving Shaft Alignment

New operating conditions require not only an improvement in the approach to shaft alignment designs and installation but a better way to verify alignment during operations. ABS worked with industry partners to address this problem, developing the Digital Shaft Alignment Monitor (D-SAM), a system that significantly enhances ship operators' ability to detect and correct issues before they result in a failure. D-SAM uses a series of proximity and temperature sensors with custom-built software to monitor the temperature of the lubricating fluid and the clearance between the surfaces of the stern-tube bearing and the propulsion shaft, helping prevent failures that can render ships inoperable.

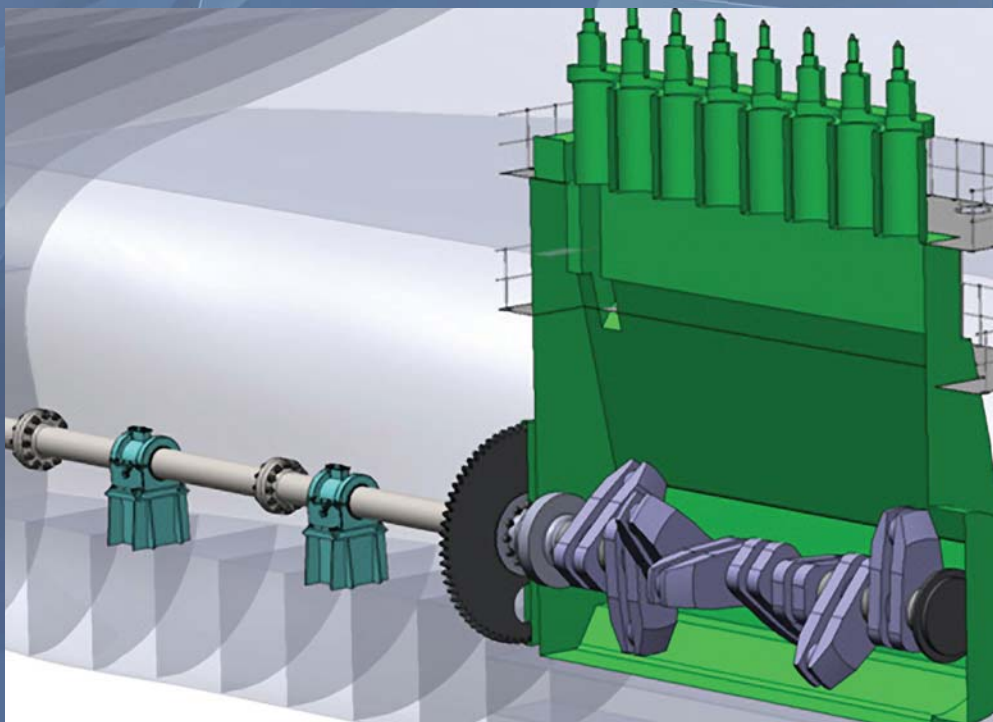

In a separate initiative, strides also were made in investigating accident sequence precursors to identify events that could lead to an offshore incident.

A big challenge for marine crews today is understanding complex, dynamic computer and network processes. Marine Technology has begun a multi-year project to investigate advantages and potential disadvantages of integrating new telemetric systems with traditional automation networks to minimize complexity to an acceptable risk level. Central to this effort is the focus on dynamic, model-based safety analysis that will enable ABS engineers to help crews deal with complexity.

LEVERAGING UNIVERSITY RESEARCH

Universities are a valuable component of the ABS R&D program. Along with the ABS technology research centers in Brazil, Canada, Korea, China and Singapore, Technology in Houston works closely on cooperative initiatives with local universities.

Advancing Subsea Pipeline Safety

As many deepwater and ultra-deepwater subsea fields come online within the next decade, offshore pipeline infrastructure has to be expanded to transport production to shore. Hyundai Heavy Industries has invested in pipeline safety by contracting with ABS to develop guidelines for subsea pipeline design criteria and training in support of front-end engineering and design (FEED). The design criteria will address issues that can arise during the early stages of the design cycle using ABS classification standards as a baseline. ABS is providing a training program to Hyundai Heavy Industries employees for applying the design criteria during the FEED phase.

For example, one university partnership in the United States addresses a broad range of subjects including numerical simulation technology for predicting surface vessel performance, ship noise emission assessment, predicting and analyzing indentation and fracturing of thin steel plating during impact and developing a vessel evaluation tool for managing risk under uncertain environmental policies and economic changes.

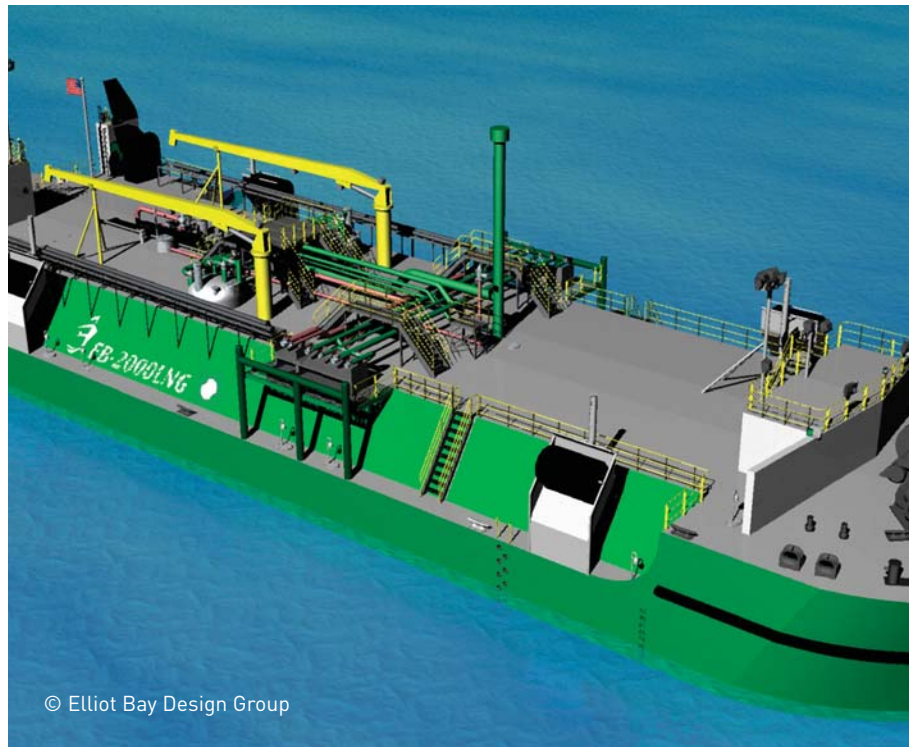

Improving Hull Performance

With the current energy and environmental regulatory landscape imposing rigorous performance standards on new construction ships, designers are seeking technical guidance on energy efficiency design index (EEDI) compliance as they navigate a competitive industry offering many eco-friendly and energy-efficient technologies. ABS has assigned a team of technical specialists in engineering, energy efficiency evaluation and computational fluid dynamics (CFD) to assist its members and clients in improving hull performance at the design phase.

One such project occurred with Shanghai Bestway Marine Engineering Design Co. and its latest 67,000-dwt bulk carrier design. Using CFD simulations, ABS specialists evaluated and assisted with refining the design performance of the original hullform as related to energy efficiency and class requirements thereby resulting in enhanced propulsive efficiency.

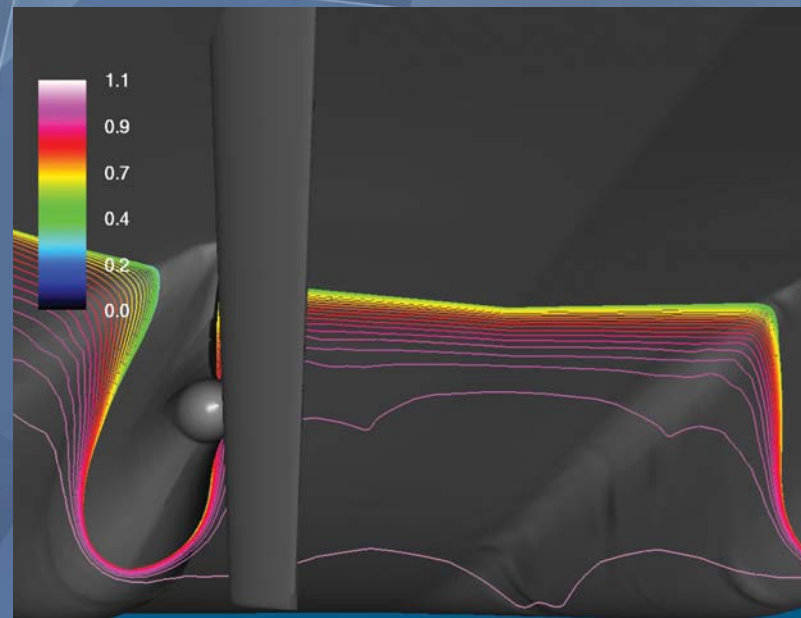

An important objective of many ABS research projects is to reduce the impact of marine and offshore surveys on operations. As part of the cooperative research, ABS is applying high-resolution sonar and optical stereo cameras with autonomous navigation to gather hull inspection results and report the condition in a three dimensional metrically accurate digital reconstruction.

Another ABS project analyzed underwater noise pollution from ships, which generally is a result of propellers, machinery or flow noise created by a hull moving through the water. In this study, ABS focused on noise radiating from a cavitating propeller and is developing a semi-empirical ship propeller cavitation noise prediction program that can be used in the early design stage.

PARTNERING WITH INDUSTRY

Asset integrity is the focus of a multi-year joint industry project (JIP) led by ABS on life cycle management that came to conclusion last year. The goal of the initiative, which was undertaken in partnership with other classification societies in addition to 11 other companies, including multiple operators, was to incorporate and/or develop new technologies to fill gaps in current practices and to leverage the JIP to support effective life cycle integrity management of offshore floating structures. The primary objectives were

The Past Inspires The Future

The search for ways to improve vessel performance often leads developers back to old ideas. The Cousteau Society has developed the Turbosail™, a propulsion technology based on the Flettner Rotor of the 1920s that harnesses wind power for auxiliary ship propulsion.

ABS' Asset Performance Management group verified the performance of the Turbosail™ concept and has taken the first steps in validating the performance of the system. This work was based on years of experimental data collected by The Cousteau Society as it tested its Alcyone and Moulin à Vent prototypes. Looking to the future, Cousteau Society and ABS teams will seek to fully validate the technology and provide initial Approval In Principle.



to promote the continuous safe operation of hull structures thereby minimizing operational downtime and prevent impact to environments.

PAVING THE WAY FOR EXPANDING LNG BUNKERING

The expanded use of liquefied natural gas (LNG)-fueled vessels will create a need for greater LNG transfer rates than those typically used for refueling the current gas-fueled ship fleet, a change that will necessitate the deployment of new bunkering equipment and operational practices. With an eye to the future, ABS invested in research to develop an LNG Bunkering Guide that provides class criteria for designing, constructing and surveying LNG bunker vessels.



Breaking Ice Barriers

ABS is collaborating with multiple industry partners in extensive R&D activities that target Arctic operations. One of these, the Sustainable Technology for Polar Ships and Structures (STePS²) project, includes laboratory experiments and associated numerical simulations aimed at developing design tools for assessing future polar class assets. STePS² project is leading research in ice-structure interaction that could play a significant role in the way companies and individuals approach working in the Arctic. The researchers of STePS² are improving the understanding of high-energy collisions between marine ice and steel structures, while gaining an improved knowledge of the resistance and failure characteristics of man-made structures under extreme ice loads.



APPLYING ADVANCED TECHNIQUES

Applying competence and experience in CFD applications has allowed ABS to take a different tack toward finding solutions to industry challenges. CFD has been employed to develop a numerical towing tank to calculate hull form resistance and has been used to support optimization efforts by designers on power and propeller performance as they look towards complying with future International Maritime Organization EEDI requirements. CFD applications extend to offshore operations as well in areas such as vortex induced vibration on mooring systems.

Another research target was to identify and offer an optional set of enhanced requirements for shaft alignment. Marine Technology developed the new *ABS Guide for Enhanced Shaft Alignment*, which identifies enhanced criteria for the evaluation of shaft alignment arrangements, such as shaft alignment optimization calculation and an increased level of effort to be carried out during construction for shaft installation and alignment.

R&D initiatives like these are fundamental to moving into new operational frontiers. Sustained investment in R&D at ABS will continue to expand the realm of what is possible. ▶

Managing Regulatory Compliance

A growing body of regulations due to be phased in over the next several years will present the industry with major compliance challenges. To provide tools that can facilitate and improve regulatory reporting, ABS enhanced the capabilities for data collection, reporting and analysis in version 6.3 of the Nautical Systems Fleet Management Solution.

For example, the new Quality Time Plan capability in the HSQE Manager addresses regulatory codes and related issues, the Work/Rest Hours functionality added to the Crew Manager aids ILO/MLC compliance, and upgrades to the Voyage and Energy Manager improve the quality and accuracy of data collected for cargo/fuel analysis and Energy Efficiency Operational Indicator calculations.





IMPROVING PERFORMANCE & POSITIONING FOR GROWTH ▶

ABS Group enjoyed continued growth and an expanded network of clients across the globe in 2014 even despite challenges such as the instability of energy prices, fluctuations in exchange rates and slowed economic growth in some of our key markets. We attribute our progress not only to our reputation for industry-leading solutions, but also to several key factors and changes which have enabled ABS Group to better serve our growing client base by providing enhanced safety, reliability and integrity services aimed at improving operational performance.

Our people make the difference with our clients, and a key management imperative is to create an environment in which our talented staff can do their best work. In late 2013, we identified opportunities to better align our service line staff, sales organizations, and support teams to improve both operational productivity and strategic goals. These changes were fully implemented in 2014 with excellent results. During the past year, we also focused on strengthening our team of technical professionals and growing our reputation for technical expertise worldwide. Thanks to our people and their dedication and professionalism, we continue to be a leading choice for innovative, reliable technical solutions for many industrial and government clients around the world.

We are also dedicated to creating safe and secure work environments for our teams. We advanced the maturity of our safety program during 2014 and we are on pace to achieve OHSAS 18000 certification in 2015. We are committed to upgrade and improve our policies and procedures as necessary.

Looking forward, ABS Group will continue to provide clients with safety, reliability and integrity services through a strategic focus on growing our footprint in specific industries and service areas. In early 2015, we will be introducing several new maintenance, reliability and integrity management services and tools aimed at helping our clients in the Offshore industry extend the life of their assets, reduce spending on capital expenditures and operating expenditures and maximize asset performance. Additionally, we plan to introduce a range of services for the North American energy and power industries to help improve operational efficiency and safety.

Over the years, market diversification has been a crucial part of our business strategy and we continue to believe that serving multiple industries and geographies has been a key to our success. While we have maintained a strong focus on the oil, gas and chemical industries, we continue to serve markets that are less exposed to oil prices and energy sector business cycles.

Although the challenges facing the upstream oil and gas market will continue in 2015, ABS Group is committed to the needs of the industry as we continue to provide high quality, innovative solutions that meet our clients' needs and help them adapt to the changing marketplace. Our reputation for technical expertise and industry-leading solutions will be our foundation as we look forward to another year of assisting our global network of clients improve the safety, efficiency and reliability of their operations.



A stylized, handwritten signature in black ink, appearing to read 'David Weinstein'.

David Weinstein
President & CEO, ABS Group of Companies, Inc.



A LEADING GLOBAL PROVIDER

2014 proved to be a successful yet challenging year as ABS Group helped an increasing number of clients operate safely, reliably, efficiently and in compliance with regulations and standards. Despite the difficulties facing upstream oil and gas markets, ABS Group achieved growth and year-on-year performance improvement by continuing to focus services on a diverse range of markets and industries.

In early 2014, ABS Group implemented several changes to improve the position of the organization for long-term growth. This included redefining organizational structures and integrating Safetec and Genesis Solutions (both acquired in 2012) around key service lines, market sectors and operating regions to enhance both client focus and service quality. Five functional service lines designed to best address client needs comprise a key element of the reorganization: Technical Inspection and Verification (TIV), Advanced Engineering (AE), Asset Performance Optimization (APO), Safety, Risk and Compliance (SRC) and Management Systems Certification (MSC).

The largest ABS Group service line, TIV, enjoyed a successful year providing project quality verification services on large-scale oil and gas projects for both independent and national oil companies. These worldwide services ranged from source inspection of equipment at vendor sites and fabrication and construction facilities to installation inspection and commissioning at project locations. The TIV and AE services lines also worked together on life cycle extension projects in which clients sought to sustain the operational availability of critical assets and defer capital spending. Engineers verified the assets' current fitness for service and developed life extension plans that included ongoing risk-based inspection activities. With capital expenditure spending deferrals

continuing to mount for the offshore industry, life extension justifications such as these become increasingly important.

Throughout 2014, ABS Group helped clients reduce costs and increase asset life and efficiency through APO services. Provided by Genesis Solutions, Enterprise Asset Management (EAM) programs helped clients maximize uptime and reduce operating expenditure costs, especially in high-value production operations in the offshore and onshore oil and gas industry, the power industry, mass transit operations and complex manufacturing. In fact, the Genesis Solutions team within ABS Group is a recognized leader in supporting EAM programs of many of the world's leading companies within the high-value and heavily regulated pharmaceutical and life sciences industry. Due to the criticality of their operations, these companies demand high reliability and quality from their process in increasingly competitive markets, which drives their focus on optimization of their reliability and maintenance management strategies as well as enhancement of their Computerized Maintenance Management Systems (CMMS). Additionally, ABS Group has enjoyed success combining the EAM services of the Genesis Solutions team with the Process Safety Management and Mechanical Integrity services of ABS Group to provide more complete Asset Performance Optimization solutions for these clients.

US BSEE Support Contract

ABS Group and the US Bureau of Safety and Environmental Enforcement (BSEE) have worked together on numerous projects over the years. In 2014, that relationship expanded as the BSEE awarded ABS Group various contracts for oil and gas support services that were completed through a joint effort between the Government and Offshore teams, with engineering support from ABS. Major objectives of the contracts included providing an increased understanding and evaluation of technologies used in the oil and gas industry and helping the BSEE identify and apply best practices developed by other countries in the International Regulator's Forum and organizations such as API. ABS Group also consulted on topics such as emergent technologies, risk data and mooring systems.



For the Oil and Gas industry, ABS Group provided these EAM services for Atlantic LNG, assisting them upgrade its maintenance and reliability software to improve the management and extend the service life of its assets. As minimizing operating expenditure expenses becomes a top priority for the oil and gas and other industries, ABS Group expects to see an increase in the demand for asset performance services.

Not only are preparedness and accident prevention of paramount importance for ABS Group, accident response is as well. When an incident does occur, SRC service line and Safetec, ABS Group's Norwegian subsidiary, help clients with assessments and investigations aimed at helping prevent future accidents. These services include: safety and condition assessments, field data evidence



Angola Activity

In 2014 ABS Group and certain affiliated companies provided Technical Inspection and Verification (TIV) services on several projects across West Africa. The TIV service line worked closely with Chevron Nigeria Limited, performing oversight inspection of materials and/or equipment at vendor premises both in Nigeria and at locations worldwide in accordance with approved inspection and test plans. ABS Group also continued support for Cabinda Gulf Oil Company Limited (Chevron subsidiary) both in Angola and worldwide, performing verification of fabrication, construction, installation, commissioning and supplier/vendor integrated inspection services. The inspection activities involved several local Angolan yards for the fabrication and production of materials. ABS Group has structural and mechanical inspectors assigned at these yards monitoring and verifying the quality of work to industry and the client's standards.



and chain-of-custody support, causal factor and root cause analyses, litigation support, recommendations for preventing accident recurrence and technical assistance in implementing those recommendations. Throughout the year, ABS Group led a record number of major incident investigations and root cause analyses of significant equipment failure and system performance problems. With such services, ABS Group helps clients identify gaps in management systems, understand equipment failures and analyze the root causes of incidents and assist in the prevention of future accidents and losses.

As concepts of corporate social responsibility gain prominence in industries around the world, ABS Group sees companies placing increasingly greater emphasis on the integrity of their global supply chains. These companies seek to verify supply chain integrity through a combination of independent audits, performed by qualified second parties to company-specific standards, and independent certification performed by recognized and accredited third parties to international standards. This trend has created new opportunities for the ABS Group MSC service line (ABS Quality Evaluations, Inc.), particularly in helping clients looking for confirmation as to the compliance of their suppliers with certain regulations related to social responsibility. In 2014 the MSC team saw extensive growth in these types of opportunities, especially in countries such as China and India. ABS Group expects growth

Nabors Drilling

Nabors Drilling turned to ABS Group in 2014 for third-party assessment of its Quality, Health, Safety and Environmental protocols on 16 rigs worldwide. The assessments covered all sections and key requirements of Nabors' Rig Management System. Following the assessment, the auditors reviewed all nonconformities with the client to confirm that the responsible personnel had an in-depth understanding of the requirements and their compliance processes. At the conclusion of each assessment, the auditors presented to Nabors' area management a summary containing specific recommendations to improve performance and provide best practices. Through such assessments ABS Group continues to prove itself a worldwide leader in QHSE Assessments.



in this area to continue over the next several years and that the SA 8000 standard will become a strong addition to traditional ISO 9001/14001 and OHSAS 18001 certification business.

ABS Group is proud to serve a global clientele, operating across a broad range of industries and in the public sector. In 2014, clients came from industries as diverse as pharmaceutical, mining, public transit and aviation. While ABS Group intends to serve clients in many markets, in early 2014 ABS Group established dedicated business development teams to focus on a number of key industries and to ensure that ABS Group continues to offer the services best suited to meet their unique needs. These teams include Offshore; Oil, Gas and Chemical; Power; Marine; and Government.

As an example of involvement in the North American oil and gas market, ABS Group provided input to the ABS LNG Bunkering study, which was received with positive feedback from both the industry and regulatory bodies.



Deepwater Wind CVA

In 2014 Deepwater Wind nominated ABS Group to provide certified verification agent (CVA) services for its Block Island Wind Farm project, which is to be located off the coast of Rhode Island. The Rhode Island Coastal Management Resources Council approved this nomination, making ABS Group the first US-based CVA for offshore wind farms. Underscoring its place as a premier provider of technical inspection services, ABS Group will serve as the CVA for the life of the facility, which includes a three-year development period and 20-year operational cycles. The five-turbine, 30-MW wind farm is expected to generate more than 125,000 MW annually.



The team also took on important projects related to North American natural gas production, distribution, storage and transportation. These projects covered waterway suitability assessments, safety and risk assessments of current and proposed operations, engineering verification for capital expenditure projects and a range of other technical services. For example, in the KOGAS LNG Bunkering Feasibility Study, ABS Group helped a major liquefied natural gas (LNG) producer navigate the beginnings of the growing North American LNG market.

ABS Group has a long history of helping government entities such as the US Department of Homeland Security optimize strategies and operating plans through the application of risk-informed decision-making. In 2014, ABS Group continued providing mission critical support for the US Department of Homeland Security with a range of services across many departments. ABS Group is helping the US Coast Guard advance its understanding and communication of risk information to optimize operational plans and resource allocation. Multi-year support for the DHS Infrastructure Security Compliance Division for the Chemical Facility Anti-Terrorism Standards has continued with great success. These are in addition to many other programs ABS Group supports across DHS, including the Transportation Security Administration (TSA), and the Federal Emergency Management Agency (FEMA) as well as the Environmental Protection Agency's Office of Emergency Management.

LNG Bunkering

In 2014, ABS Group worked on a project together with ABS to develop and publish the LNG Bunkering Report, the first study of its kind to be published in North America. Offering insight and assistance for companies transitioning to LNG bunkering, the report has attracted to ABS Group several major organizations which are seeking help with LNG initiatives. Separately, KOGAS-Tech, the engineering services and R&D company owned by KOGAS, the world's largest purchaser of LNG (by volume), sought ABS Group assistance on questions regarding the feasibility and market for a North American LNG bunkering facility to support trans-Pacific, LNG-fueled cargo ships. ABS Group is also assisting KOGAS with conceptual studies for a floating storage and regasification unit terminal.



In 2014, ABS Group also became a leading support contractor for another part of the US government, the Bureau of Safety and Environmental Enforcement (BSEE). ABS Group provided the BSEE with a range of support services aimed at the oil and gas industry, such as helping identify and apply best practices and consulting on such topics as emergent technologies, risk data and mooring systems. Its combination of technical expertise, highly qualified performance consultants and offshore industry experience across the globe made ABS Group the ideal choice for helping the BSEE handle a number of research and organizational development tasks. In fact, among the SRC team, including the Safetec subsidiary, ABS Group brings unrivaled understanding and experience with all of the major offshore regulatory regimes and implementing agencies from around the world, including those covering the Gulf of Mexico (US and Mexico), the North Sea (Norway and the UK), Brazil, and Australia.



Genesis Technology Solutions

In 2014, Genesis Technology Solutions (Genesis), the APO arm of ABS Group, performed a large-scale maintenance and reliability project for Atlantic LNG. The project included a major upgrade to the client's IBM Maximo maintenance and reliability software, from version 5.2 to version 7.5, along with installing its Oil and Gas Industry Solution, Maximo Scheduler and Maximo Mobile applications. Genesis provided overall project management and support services, a process review and a gap analysis to confirm the functionality of the upgraded applications and is currently providing application support through a one-year support contract.



ABS Group also continued its role in the power industry as a globally-recognized provider of such nuclear-oriented services as probabilistic risk assessments and risk migration for nuclear power plants. The Fukushima disaster of 2011 raised many questions about the exposure of nuclear plants to seismic events and prompted the development of new regulations and industry standards for vulnerability assessment. In 2014, ABS Group performed one of the first post-Fukushima seismic risk assessments for a major nuclear plant operator.

In 2014, ABS Group continued to be a leading global provider of technical services that better enable clients to operate safely, reliably, efficiently and in compliance with regulations and standards. As industries evolve and new challenges arise in the coming year, ABS Group will continue to assist clients in both adapting to those changes and creating safer, more efficient operations. ▶

Managing Risk On First Barents Sea Installation

Many factors will influence the design and operation of offshore assets in Arctic and extreme cold conditions, and meeting these demands safely will require next-generation solutions.

One of those solutions will be the integrated barrier management system Safetec is building for the *Goliat* FPSO on behalf of operator Eni Norge AS. Built to harsh environment specifications, *Goliat* will be the first production unit installed in the Barents Sea.

On schedule for 2015 installation, the FPSO is a highly sophisticated platform requiring an extensive integrated solution to meet PSA Norway requirements. Safetec's method involves charting, verifying and managing barriers to verify a high level of safety and follow-up of safety critical barriers during operation.

Safetec is working closely with 'High North' operators to maintain the same risk level applied to the rest of the Norwegian Continental Shelf, with a focus on reducing emissions to zero and the goal to help drive increased safety measures so accidents can be avoided in this environmentally sensitive area.





CULTIVATING THE INDUSTRY'S FUTURE LEADERS ▶

The innovators and leaders of tomorrow are the curious students being shaped by educational experiences today. Through planned philanthropic giving to academic institutions, ABS helps this pool of talent develop into the motivated professionals who will solve the challenges of the future in the marine and offshore industries.

For over eight decades, ABS has supported education in various ways, believing this support is key to advancing the industries ABS serves. ABS is proud to have long standing relationships with these prestigious institutions and continues to nurture the future through the ABS Scholarship and Education Funding Program. This program provides investment commitments that include chair endowments, buildings and academic program development.



ABS helps educate future innovators and leaders through the support of academic chairs and professorships in the United States and abroad. ABS' ongoing relationship with key institutions includes chair endowments with the ABS Chair in Naval Architecture and Marine Engineering at The Webb Institute; the



ABS Chair of Naval Architecture and Marine Engineering and ABS Chair of Marine Transportation for the State University of New York (SUNY) Maritime College; the ABS Chair in Naval Engineering at the Massachusetts Institute of Technology (MIT); the University of Michigan's ABS Chair in Marine and Offshore Design Performance; and the ABS Chair at the University of California Berkeley. Internationally, educational efforts include the ABS Chair at the Singapore University of Technology and Design (SUTD). And in 2014, ABS established an endowed faculty chair for the Colorado School of Mines, bolstering its research and educational offerings in metallurgical and materials engineering.

In addition to endowed chairs, ABS also supports these institutions by providing infrastructure investments believing world-class facilities help build world-class talent. ABS provided building support for the ABS Lecture Hall at California Maritime Academy; the ABS Center for Engineering, Science and Research at Maine Maritime Academy; the ABS Information Commons at Massachusetts Maritime Academy; the ABS Civil, Mechanical and Naval Engineering Laboratory Complex at Stevens Institute of Technology; and the ABS Science and Engineering Lecture Hall at SUNY Maritime College.



ABS supported academic program development at the US Coast Guard Academy and the City University of London's Cass Business School. In addition, ABS supported scholarships at more than 70 universities around the world and provided opportunities for interns to work with the organization and potentially become full-time employees and members of the ABS team.

Lastly, believing that nurturing the next generation of marine and offshore leaders cannot start soon enough, in 2014, ABS donated a bridge simulator to the New York Harbor School, a high school which provides young people with a college preparatory education built on New York City's long and prominent maritime history.

Through these efforts over the last eight decades and continuing in 2014 and beyond, ABS nurtures the most innovative minds to develop future engineers, surveyors and other professionals. Consistent with its mission, ABS is committed to building the future talent that will continue to move the maritime and offshore industries forward. ▶

ABS BOARD OF DIRECTORS



Michael L. Carthew
Chevron Shipping Company LLC



Choo Chiau Beng
Keppel Corporation Ltd.



Dr. Peter H. Cressy
DISCUS



Richard D. DeSimone
XL Insurance



John A. Hickey



William E. Jenkins



Philip J. Shapiro
Liberty Maritime Corporation



Craig H. Stevenson, Jr.
Diamond S Shipping, LLC



Dean E. Taylor



Elizabeth D. Whitaker, Esq.



Christopher J. Wiernicki
ABS



Douglas C. Wolcott
Wolcott Associates

ABS CORPORATE OFFICERS

Christopher J. Wiernicki
Chairman, President &
Chief Executive Officer

Tony Nassif
Executive Vice President &
Chief Operating Officer

Kenneth L. Richardson
Executive Vice President

Jeffrey J. Weiner
Executive Vice President &
Chief Financial Officer

Robert G. Clyne, Esq.
Senior Vice President,
General Counsel & Secretary

Vikki M. Dunn
Senior Vice President

Todd W. Grove
Senior Vice President &
Chief Technology Officer

Maria F. O'Neill
Senior Vice President &
Chief Information Officer

John A. Ryder
Senior Vice President

James J. Gaughan
Vice President & Chief Engineer

Eric C. Kleess
Vice President,
Division President – Greater China

Adam W. Moilanen
Vice President

Derek S. Novak
Vice President,
Division President – Pacific

Joseph O. Riva
Vice President & Chief Surveyor

Kirsi Tikka
Vice President,
Division President – Europe

James A. Watson, IV
Vice President,
Division President – Americas

ABS ADVISORY COUNCIL

Saleh A. Al-Shamekh
Bahri Oil & Gas (Dubai)

John A. Angelicoussis
Anangel Maritime Services Inc.

Morten Arntzen
Castine Maritime Group

Mark W. Barker
Interlake Steamship Company

William T. Bennett, Jr.
Mindoc LLC

Michael L. Carthew
Chevron Shipping Company LLC

Angela A. Chao
Foremost Group

Choo Chiau Beng
Keppel Corporation Ltd.

Robert G. Clyne, Esq.
ABS

John G. Coumantaros
Southern Star Shipping Co. Inc.

Thomas B. Crowley, Jr.
Crowley Maritime Corporation

Cesare d'Amico
d'Amico Società di Navigazione SpA

Robert A. DeMotta
Aon Risk Services of New York

Richard D. DeSimone
XL Insurance

Lawrence R. Dickerson
Diamond Offshore Drilling Services Inc.

Richard T. du Moulin
Intrepid Shipping, LLC

Dimitrios J. Fafalios
Fafalios Shipping S.A.

John D. Fafalios*
Fafalios Shipping S.A.

Nicholas G. Fistes
ADK Maritime Pte Ltd.

Angeliki N. Frangou
Navios Shipmanagement Inc.

James J. Gaughan
ABS

Peter George Goulandris*
Capeside Steamship Co. Ltd.

Peter John Goulandris
Triandros Corporation

William O. Gray*

Todd W. Grove
ABS

Frederick J. Harris
General Dynamics NASSCO

Bengt Hermelin
Samco Shipholding

John A. Hickey	Adam W. Moilanen ABS	Capt. Cesare Sorio*
Michael S. Hudner B+H Shipping Group	Tony Nassif ABS	P.K. Srivastava*
Datuk Nasarudin bin Md Idris MISC Berhad	Maria F. O'Neill ABS	Craig H. Stevenson, Jr. Diamond S Shipping, LLC
Paul J. Ioannidis* Alexander S. Onassis Foundation	C.R. Palmer*	Dean E. Taylor
William E. Jenkins	Stephen Y.K. Pan World-Wide Shipping Agency Ltd.	Kirsi Tikka ABS
Capt. Robert E. Johnston	Pericles S. Panagopoulos* Magna Marine Inc.	Nikolaos P. Tsakos Tsakos Energy Navigation Ltd.
Capt. Spyros N. Karnessis European Navigation Inc.	Basil Phrixos Papachristidis Hellasport Steamship Corporation	Frank W.K. Tsao* IMC Group of Companies
Eric C. Kleess ABS	T. Peter Pappas Atlantic Capital LLC	Tung Chee Chen Orient Overseas International Ltd.
Renee Klimczak	Cristina Lucia Duarte Pinho Petroleo Brasileiro S/A-Petrobras	Michael D. Tusiani Poten & Partners, Inc.
David C.C. Koo Valles Steamship Company, Ltd.	Spyros M. Polemis Seacrest Shipping Company Ltd.	Leonard H. Tyler
Charles Kurz, II*	Antony Prince G.T.R. Campbell Marine Consultants Ltd.	Richard H. Vortmann* RHV Company LLC
Donald R. Kurz Keystone Shipping Company	John F. Reinhart The Port of Virginia	James A. Watson, IV ABS
Gerhard E. Kurz*	Kenneth L. Richardson ABS	Jeffrey J. Weiner ABS
Joseph Kwok Seacastle Inc.	Bruce S. Rosenblatt Bruce S. Rosenblatt & Associates, LLC	Capt. Graham Westgarth GasLog Ltd.
John P. Laborde*	Dott. Alcide Ezio Rosina* Premuda	Christopher J. Wiernicki ABS
Michael C. Lemos C.M Lemos & Company Ltd.	Stefano Rosina Premuda	David W. Williams Noble Corporation
Dr. Donald Liu	John A. Ryder ABS	Douglas C. Wolcott Wolcott Associates
Peter G. Livanos GasLog LNG Services Ltd.	Philip J. Shapiro Liberty Maritime Corporation	Michael Wyllie SBM Offshore N.V.
Dr. Frank F.H. Lu Yang Ming Marine Transport Corporation		Adm. Paul F. Zukunft US Coast Guard
Shigeru Matsui Matsui & Company, Ltd.		

*Emeritus Member

ABS GROUP BOARD OF DIRECTORS



Dennis M. Houston



Robert E. Kramek



T. Peter Pappas
Atlantic Capital LLC



David Weinstein
ABS Group of Companies, Inc.



Christopher J. Wiernicki
ABS

ABS GROUP CORPORATE OFFICERS

Christopher J. Wiernicki
Chairman

David Weinstein
President & Chief Executive Officer

David A. Walker
Chief Operating Officer

Sarah M. Barton
Vice President,
General Counsel & Secretary

Robert G. Clyne, Esq.
Assistant Secretary

Jeffrey J. Weiner
Chief Financial Officer

James Clutterbuck
Treasurer

The mission of **ABS Group of Companies** is to be a leading global provider of technical services that better enables our clients to operate safely, reliably, efficiently and in compliance with applicable regulations and standards. We are focused on adding value to the industries we serve and strategically capturing synergies with ABS.



16855 Northchase Drive
Houston, TX 77060 USA
Tel: 1-281-877-5800
Fax: 1-281-877-5803
Email: abs-worldhq@eagle.org



www.eagle.org